

TEKMARINE



Marine Bollards



About TekMarine

From its base in the United States, TekMarine Systems LLC designs and supplies advanced marine fendering and mooring systems to ports, harbors and waterways across the world.

We bring a wealth of engineering and market experience to each project. Our fender solutions range from simple modules to the most sophisticated engineered systems. We supply every type of berth, including passenger terminals, bulk and RoRo ports, Oil and Gas installations and naval facilities.

We offer full support at each step from early concept discussions through to design and detailing, material selection, construction, testing, shipping, and installation. A full after-care service helps keep your investment working safely and reliably for many years after commission.

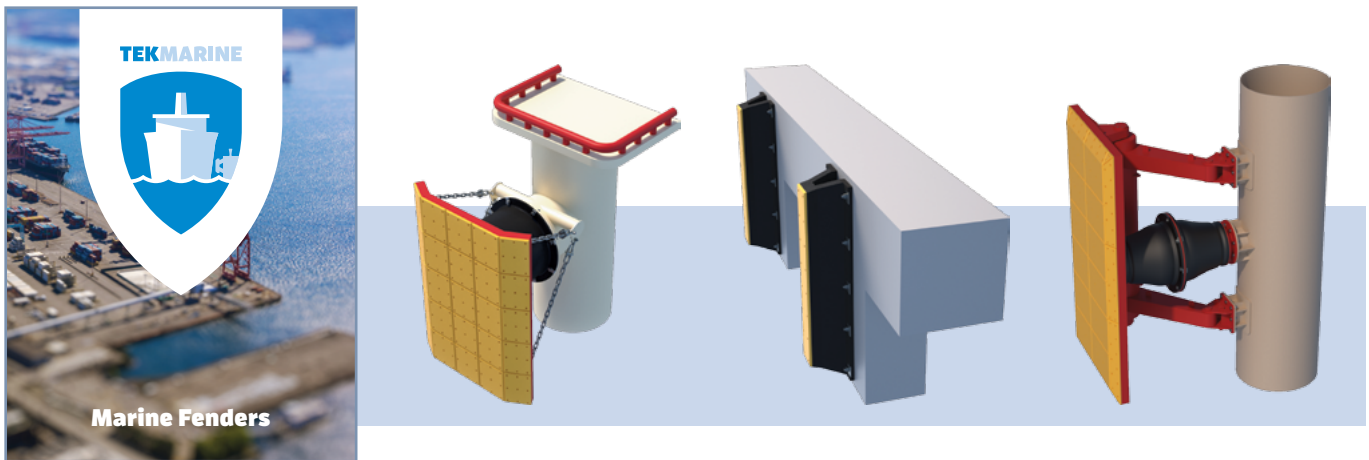

Disclaimer

TekMarine Systems LLC ("TekMarine") has made every effort to ensure that the product descriptions and technical specifications in this catalog are correct. TekMarine can not accept liability or responsibility for errors and omissions for any reason. Customers and catalog users are kindly requested to ask TekMarine for a detailed specification and approved drawings before manufacturing and construction. TekMarine reserves the right to make changes to specifications and drawings without prior notice. All dimensions, performance values, material properties and other product specifications are subject to standard tolerances. This catalog and the information herein replaces all earlier editions. If in any doubt, please contact TekMarine.

Copyright

Copyright © 2016 TekMarine Systems LLC. All rights reserved.

This catalog may not be reproduced, copied or distributed to third parties without the consent of TekMarine Systems LLC in every case.

TekMarine bollards

Every TekMarine bollard is designed for maximum strength and a long working life with the minimum of maintenance. Careful material and coating selection, Finite Element Analysis (FEA) and strict testing mean that every bollard behaves exactly as expected.

Material choices include cast SG Iron and cast steel. Please ask us about optional Charpy testing for cold-weather applications.

Even the best bollard relies on a safe foundation. That is why TekMarine offers a choice of anchors to suit new-build and retrofit installations. We offer the most durable coatings as standard and many other finishes on request.

The TekMarine bollard range includes all types, sizes and load capacities. There is a bollard to match every port's environment and workload. Contact us today to find out more about the ideal bollard for your mooring project.

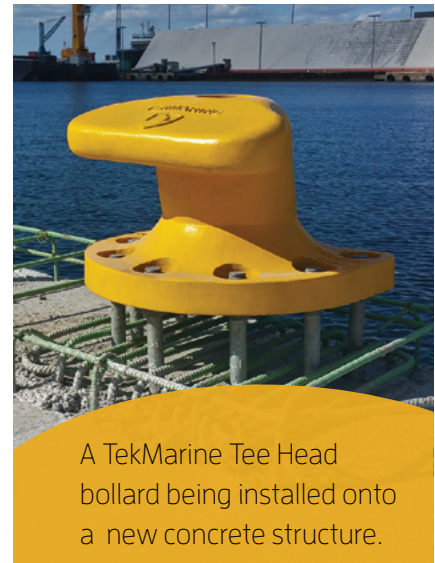

A TekMarine Tee Head bollard being installed onto a new concrete structure.

Contents

Single Bitt Bollard	4
Double Bitt Bollard	5
Tee Bollard	6
Stag Horn Bollard	7
Kidney Bollard	8
Mooring Cleats	9
Materials	10
Coatings	11
Quality / Design Guidelines	11
Selecting Bollards	12
Anchor Systems	13
Bollard Specification Form	14
Frequently Asked Questions	15
Maintenance	16
Inspection Form	18
Unit Conversions	19



Tee Head Bollard

The Tee Head Bollard is the world's favorite design choice. It accommodates mooring lines from all vessel sizes and types, at higher angles than Single or Double Bitt models. Its uses the minimum of valuable space along the quay.

- Up to 300t capacity on request
- Compact footprint
- Choice of materials to suit climate and application
- Accepts very steep line angles
- Perfect for multi-use facilities

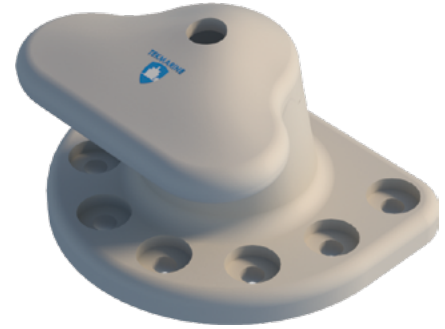

Dimensions

Bollard capacity (metric tonnes)	A	B	C	D	E	F	G	H	I	J	K	L	M	Bolt	
	(mm)	(mm)	(mm)	(mm)	(mm)	(mm)	(mm)	(mm)	(mm)	(mm)	(mm)	(mm)	(mm)	Size	Qty.
10	240	304	380	330	50	-	-	230	107	-	-	280	140	M24	4
15	270	333	416	339	55	-	-	255	90	-	-	306	131	M24	4
20	282	349	436	359	55	-	229	304	0	137	-	325	141	M24	5
30	294	364	455	379	60	-	235	319	0	145	-	335	152	M30	5
50	390	456	570	482	70	-	305	412	0	186	-	430	197	M36	5
75	445	520	650	550	75	-	290	442	125	242	-	500	225	M42	6
100	492	616	770	630	85	297	475	545	0	193	295	600	245	M42	7
125	511	669	836	715	100	351	541	615	0	207	313	636	297	M48	7
150	530	718	898	748	110	358	559	638	0	219	334	678	299	M48	7
200	598	765	956	825	120	347	557	687	111	290	358	716	347	M56	8

Bollard capacity (metric tonnes)	A	B	C	D	E	F	G	H	I	J	K	L	M	Bolt	
	(in)	(in)	(in)	(in)	(in)	(in)	(in)	(in)	(in)	(in)	(in)	(in)	(in)	Size	Qty.
10	9 1/2	12	15	13	2	-	-	9	4 1/4	-	-	11	5 1/2	1	4
15	10 5/8	13 1/8	16 3/8	13 3/8	2 1/8	-	-	10	3 1/2	-	-	12	5 5/8	1	4
20	11 1/8	13 3/4	17 1/8	14 1/8	2 1/8	-	9	12	0	5 3/8	-	12 3/4	5 1/2	1	5
30	11 5/8	14 3/8	17 7/8	14 7/8	2 3/8	-	9 1/4	12 1/2	0	5 3/4	-	13 1/4	6	1 1/8	5
50	15 3/8	18	22 1/2	19	2 3/4	-	12	16 1/4	0	7 3/8	-	16 7/8	7 3/4	1 3/8	5
75	17 1/2	20 1/2	25 5/8	21 5/8	3	-	11 3/8	17 3/8	4 7/8	9 1/2	-	19 3/4	8 7/8	1 5/8	6
100	19 3/8	24 1/4	30 3/8	24 7/8	3 3/8	11 3/4	18 3/4	21 1/2	0	7 5/8	11 5/8	23 5/8	9 5/8	1 5/8	7
125	20 1/8	26 3/8	32 7/8	28 1/8	4	13 7/8	21 1/4	24 1/4	0	8 1/8	12 3/8	25	11 3/4	1 7/8	7
150	20 7/8	28 1/4	35 3/8	29 1/2	4 3/8	14 1/8	22	25 1/8	0	8 5/8	13 1/8	26 3/4	11 3/4	1 7/8	7
200	23 1/2	30 1/8	37 5/8	32 1/2	4 3/4	13 5/8	21 7/8	27	4 3/8	11 3/8	14 1/8	28 1/4	13 5/8	2 1/4	8

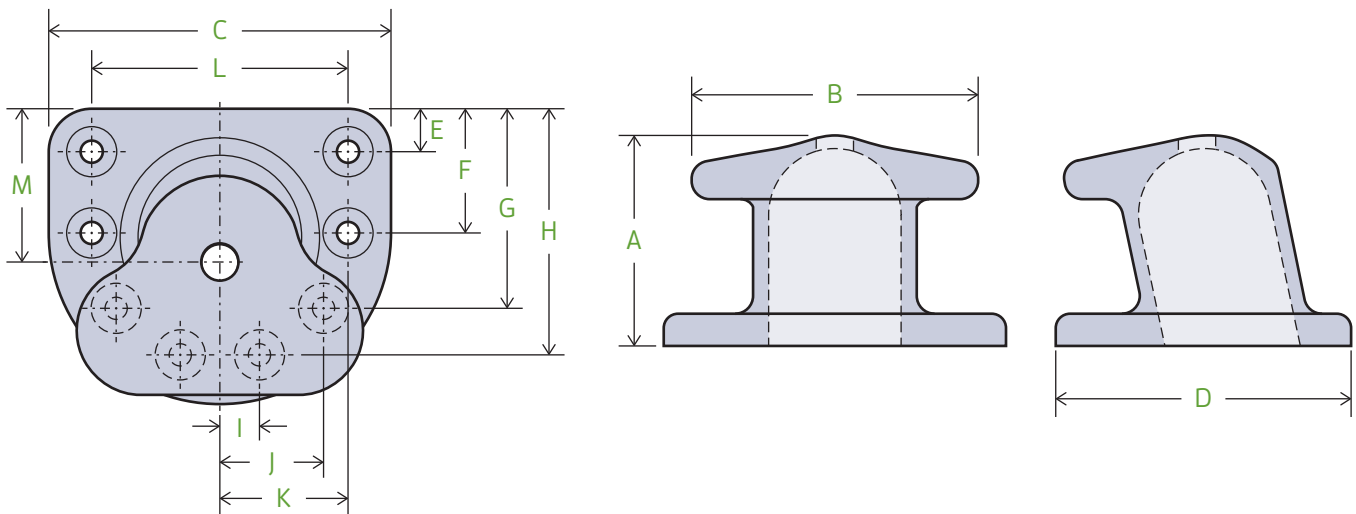

Spheroidal Graphite (SG) Iron and Cast Steel are the commonest materials for bollards. Both can be used for the majority of applications. TekMarine does not recommend gray cast iron.

SG Iron

SG Iron has the better corrosion resistance and cost per weight, while cast steel offers higher impact resistance. SG Iron is a popular choice for warmer environments. SG Iron bollards tend to weigh more due to a thicker cross-section. However they cope better with coating damage and their surface allows for clearer cast-in details such as names and serial numbers.

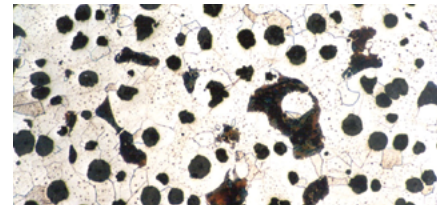

Cast Steel

Cast steel may be more suitable for cold climates. Minor repairs can be carried out by suitably qualified welders, and bollards may even be welded to existing steel structures. Regular inspection and maintenance may be required to ensure a long and trouble-free working life. Charpy testing is strongly recommended for cold-weather applications. Bollards may be cast with a "test coupon" that can be detached for these procedures.

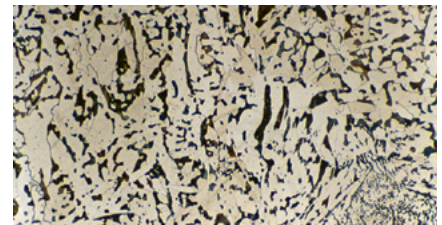

Material properties

The material properties given below are typical values, based on tests of sample pieces. Other materials grades are available on request. For more details please consult Tekmarine.

Material	Standard	Grade	Tensile strength		Yield strength		Elongation
			MPa	ksi	MPa	ksi	%
SG Iron	ASTMA536	65-45	450	65	310	45	12
Cast Steel	ASTMA27	65-35	450	65	240	35	24

Safety factors and calculations

TekMarine bollards and anchors are designed with a safety factor of three for the breaking load, anchor bolts, and concrete pullout (given a 40MPa concrete). The berth's designer is responsible for its final structure and steel reinforcement.

Engineering calculations are provided with bollard systems, describing bolt group pullout forces, shear loadings and bolt tensions. More details and detailed safety calculations can be provided on request, subject to extra cost.

Typical design standards:

BS 6349-2:2010, Structural use of steelwork
BS EN 1993:2005, Design of steel structures
AS 3990-1993, Mechanical equipment – steelwork
AISC Steel Construction Manual, latest edition
ACI 318, Appendix D, latest edition

Local codes and regulations may also apply.



Coating systems

Great care must be taken not to damage the bollard's original factory coating during installation. The recommended grade for long-term corrosion resistance in marine environments is C5M (ISO 12944). Suitable paints are supplied by International Paint (Akzo Nobel) among others. Other coatings, such as bituminous or primer, are available on request. Mooring Cleats are usually supplied painted, alternatively with a hot dip galvanized coating, and other finishes can be applied. Please ask TekMarine about the most suitable coating for your application.

Mooring lines continuously wear and abrade even the toughest coatings. We recommend a regular inspection and maintenance schedule, and repairs to the finish of any worn areas.

Coating grades

Coating/preparation	Standard	Grade
Blasting	ISO 12944	SA 2.5
Bituminous paint	BS 3416:1991	Single coat
Corrosion resistant paint	ISO 12944	C5M
Galvanized anchor bolts	ISO 898-1:2013	Grade 8.8

Sample C5M specification

Layer	Number of coats	Thickness (µm)
2-part, zinc-rich epoxy primer	1	40-60
2-part epoxy primer	2-3	160-220
Acrylic top coat	1	60
Total (dry film)	4-5	320

Quality

TekMarine takes quality and safety seriously. Our typical package of quality documents includes:

- Dimensioned drawings of bollards and anchors
- Calculations on bollards and anchor systems
- Installation advice
- Casting inspection
- Casting test report
- Coating inspection/test report
- Others as required

Design guidelines

Guideline/code	Details
Design Facilities Criteria	<i>UFC 4-152-01 Design: Piers and Wharves</i> . US Dept. of Defense, 2005 <i>UFC 4-159-03 Design: Moorings</i> . US Dept. of Defense, updated 2012.
OCIMF MEG3	<i>Mooring Equipment Guidelines, 3rd Edition</i> . Oil Companies International Marine Forum, 2008.
BS 6349-4	<i>Maritime Works – Part 4: Code of practice for design of fendering and mooring systems</i> . BSI 2014
ROSA 2000	<i>Recommandations pour le calcul aux états-limites des ouvrages en site aquatique (Recommendations for calculating the limit states of works in water)</i> . METL/CETMEF, First edition, 2000.
ROM 3.1-99	<i>Recommendations for Maritime Works</i> . Puertos del Estado, 2000. English Edition 2007. – Part III, <i>Vessel Manoevrability Characteristics</i> – Part IV, <i>External Actions on a Vessel</i>
TR-6056-OCN	<i>Mooring Loads due to Parallel Passing Ships</i> . Naval Facilities Engineering Services Center, 2005.
EAU 2012	<i>Recommendations of the Committee for Waterfront Structures, Harbours and Waterways EAU 2012</i> . Ernst & Sohn, 9th Edition, 2015.
Mooring and Anchoring Ships	<i>Mooring and Anchoring Ships</i> . Nautical Institute. Vol 1, 2003. Vol 2, 2009.
OCDI 1999	<i>Technical Standards and Commentaries for Port and Harbour Facilities in Japan</i> . Overseas Coastal Area Development Institute of Japan, English Edition, 2002.



Selecting bollards

Once local regulations and applicable design standards have been taken into account, designers should consider:

- Draft changes
- Water level changes
- Forces due to wind and currents
- Forces due to waves, swell and tides
- Forces due to ice (if required)
- The type, size and angle of mooring lines
- Anchor type and mounting method
- Overload prevention

When mooring loads cannot be calculated, the table of ship sizes provides a guideline. Allow for a 25% increase in bollard capacity if adverse loads are anticipated.

Ship sizes

Displacement	Approx. bollard capacity (tonnes)
< 2,000	10
2,000–10,000	30
10,000–20,000	60
20,000–50,000	80
50,000–100,000	100
100,000–150,000	150
150,000–200,000	200
> 200,000	300

Angles and spacing

According to common codes, bollards should be spaced at intervals of 15% of the shortest ship design used on the berth. Spacings are commonly between 10–30m (30–90ft). This often coincides with fender placement or midway between fenders, or halfway between expansion joints on continuous structures.

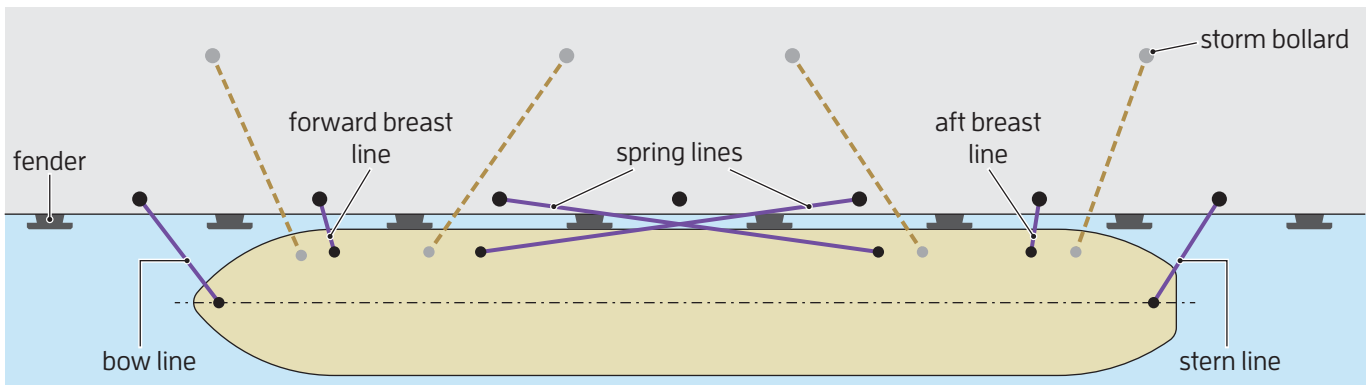

Fully laden

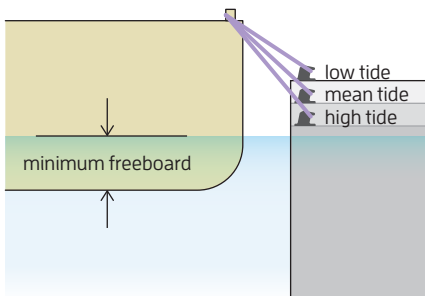

Low draft

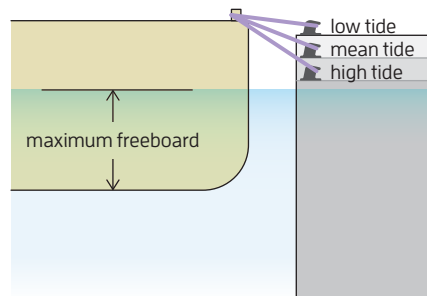

Mooring line angles should be calculated as part of a full mooring simulation. Vertical angles should be minimized. Horizontal angles are relative to the vessel's main axis.

Head and stern lines	$45^\circ \pm 15^\circ$
Breast lines	$90^\circ \pm 30^\circ$
Spring lines	$5\text{--}10^\circ$
Vertical line angle	$\leq 25^\circ$

See PIANC, BS 6349-4 and ROM 3.1-99.



Anchor systems

Every bollard system relies on a safe, dependable anchor system. The type and length of anchor depends on the quay structure itself. For new concrete quays, cast-in anchor bolts with load spreading plates should be specified, and the bollards should be "flush-mounted" if possible. Epoxy grout systems are typical for retrofit and replacement bollards on concrete structures. Bollards can also be fitted using "through bolts" on reinforced or steel decks.

Cast-in anchors

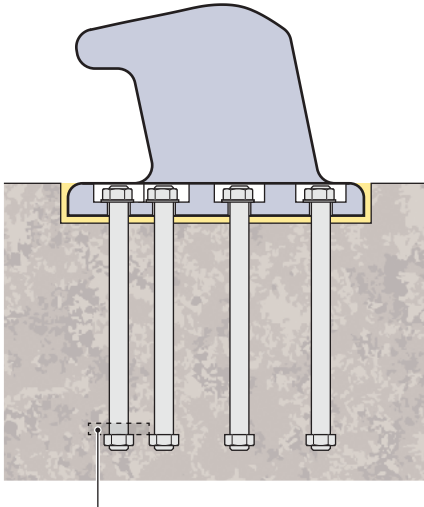

Optional anchor plate

Retrofit anchors

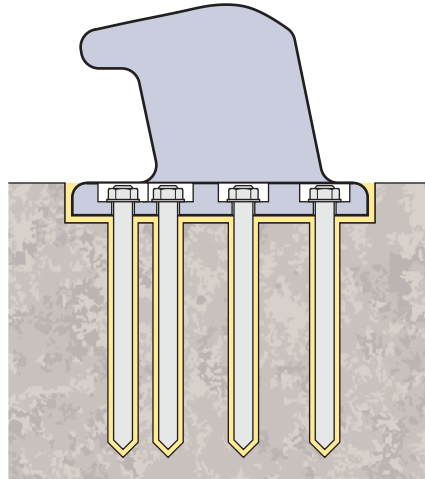

Through bolts

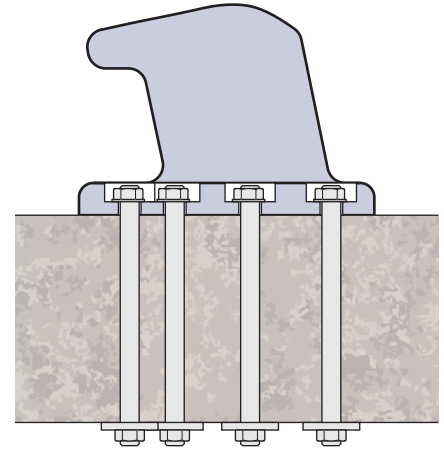

Anchor materials

Part	Standard	Grade
Bolt	ISO 898	8.8
Nut	ISO 898	8
Washer	ISO 887	-
Plate	ISO 630	-

Standard, duplex and super duplex stainless grades can be requested. Please note that new calculations would be required at extra cost.

All recalculations should be carried out by a qualified engineer.

Bolts sizes are such that most test codes do not apply. They are therefore tested at half the bolt radius as specified by ASTM F606.

Anchor plates

Cast-in anchors are usually supplied as simple bolts terminated with nuts. Please speak to us about additional, wider anchor plates if they are explicitly required by your project specification.

Preloading anchors

Anchor bolts should be preloaded to reduce fatigue due to repetitive tensile stresses caused by wind, waves and other factors. This should prevent nuts backing off the anchors and improve the working life of the bollard anchor system.

Grout

Non-shrink cementitious or epoxy grouts with a compressive strength of at least 60MPa are recommended. Low viscosity, high flow grouts should always be specified for recessed bollards.

Anchor templates

For installations that require drilling, flexible templates can be produced to match base plate layouts. We also recommend the use of removable steel 'pour-in' templates to guide the positioning of anchors and baseplate recesses in new concrete structures. Please ask TekMarine for more details.







Bollard specification form

Project	
Port	
Berth	
Project type	<input type="checkbox"/> New build <input type="checkbox"/> Upgrade
Enquiry type	<input type="checkbox"/> Preliminary <input type="checkbox"/> Detail <input type="checkbox"/> Tender

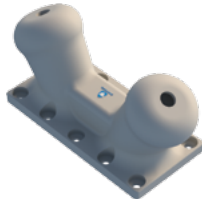
Contact	
Name	
Company	
Position	
Telephone	
Email	
Web	

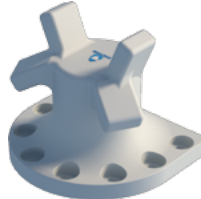
Bollards

					
<input type="checkbox"/> Single Bitt	<input type="checkbox"/> Double Bitt	<input type="checkbox"/> Tee Head	<input type="checkbox"/> Stag Horn	<input type="checkbox"/> Kidney	<input type="checkbox"/> Mooring Cleat
SWL	SWL	SWL	SWL	SWL	SWL
Quantity	Quantity	Quantity	Quantity	Quantity	Quantity
<input type="checkbox"/> Flush Mount <input type="checkbox"/> Surface Mount	<input type="checkbox"/> Flush Mount <input type="checkbox"/> Surface Mount	<input type="checkbox"/> Flush Mount <input type="checkbox"/> Surface Mount	<input type="checkbox"/> Flush Mount <input type="checkbox"/> Surface Mount	<input type="checkbox"/> Flush Mount <input type="checkbox"/> Surface Mount	<input type="checkbox"/> Flush Mount <input type="checkbox"/> Surface Mount
<input type="checkbox"/> SG Iron <input type="checkbox"/> Cast Steel <input type="checkbox"/> Other	<input type="checkbox"/> SG Iron <input type="checkbox"/> Cast Steel <input type="checkbox"/> Other	<input type="checkbox"/> SG Iron <input type="checkbox"/> Cast Steel <input type="checkbox"/> Other	<input type="checkbox"/> SG Iron <input type="checkbox"/> Cast Steel <input type="checkbox"/> Other	<input type="checkbox"/> SG Iron <input type="checkbox"/> Cast Steel <input type="checkbox"/> Other	<input type="checkbox"/> SG Iron <input type="checkbox"/> Cast Steel <input type="checkbox"/> Other
<input type="checkbox"/> C5M Paint <input type="checkbox"/> Bituminous/primer <input type="checkbox"/> Galvanised	<input type="checkbox"/> C5M Paint <input type="checkbox"/> Bituminous/primer <input type="checkbox"/> Galvanised	<input type="checkbox"/> C5M Paint <input type="checkbox"/> Bituminous/primer <input type="checkbox"/> Galvanised	<input type="checkbox"/> C5M Paint <input type="checkbox"/> Bituminous/primer <input type="checkbox"/> Galvanised	<input type="checkbox"/> C5M Paint <input type="checkbox"/> Bituminous/primer <input type="checkbox"/> Galvanised	<input type="checkbox"/> C5M Paint <input type="checkbox"/> Bituminous <input type="checkbox"/> Galvanised

Vessels		
Length	L _{OA}	L _{OA}
Displacement	M _D	M _D
Deadweight	DWT	DWT

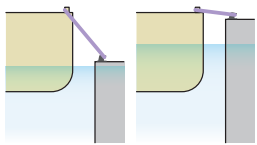
Line angles			
	Min°	Min°	
	Max°	Max°	

Other information

Please return this completed form to info@tekmarine.com.



Frequently asked questions

Berth design and materials

Calculations are based on a concrete strength of 40MPa, which is frequently used for new facilities.

A high safety factor is applied to concrete strength. Because this allows for variations in berth structures, it is acceptable to use 30MPa concrete (if a reduction in this safety factor is permitted).

TekMarine specializes in mooring and fendering equipment. We excel at meeting the requirements of clients and their structural engineers, but we cannot recommend one structural choice over another. This includes reinforcing concrete structures to reduce edge distances, shear bracing, and concrete strength. These matters should always be raised with the quay designer.

Bollard selection

The right choice of bollard, its site and its orientation depend on many factors. These include vessel size, local weather, water depth, currents, tides and the quay configuration. The careful analysis of these factors and the final bollard selection rests with the quay designer.

Technical support

Advice on design and technical matters is available from TekMarine Systems. Please call your nearest TekMarine sales office or representative, or email: engineering@tekmarine.com.

Standard designs

The TekMarine range is based on the most popular bollard shapes, sizes and capacities. Some clients may prefer other designs for historical reasons. Unless these requirements are essential, TekMarine will always recommend the most suitable standard bollard type, which will meet or even exceed functional mooring requirements.

Bolt specification

Anchor bolts are described in the product list and every general arrangement drawing.

All bolts are ISO 898-1 Grade 8.8, hot dip galvanized and supplied with one nut and washer as standard.

Because bollard bolts are so large, the standard testing criteria in most fastener codes are rarely applicable. Proportional load testing methods, based on half the bolt radius, are used instead. Other material grades can be supplied, either hot dip galvanized or in stainless steel. These may demand new engineering and design at additional cost.

Load testing

TekMarine bollards are designed using modern engineering techniques and software, such as FEA analysis. These combine very accurate load scenarios with high factors of safety, eliminating the need for costly physical load testing.

Physical testing is expensive and technically difficult. Set-up costs may reach tens of thousands of dollars. TekMarine can arrange testing on request, if these extra costs are agreed in advance.

Non-destructive testing

Each foundry heating is accompanied by a material mechanical property test report, demonstrating that the material meets the minimum strength requirement. Other tests such as magnetic particle inspections, die penetrant inspection or ultrasonic testing may be conducted at further cost, depending on the test regime.

Bollard material

TekMarine bollards are offered in cast steel and spheroidal graphite cast iron ('SG Iron' or 'Ductile Cast Iron'). Cast steel is often stronger and can be configured for cold climates. SG Iron resists impacts and corrosion better and is ideal for hotter and more humid climates. We do not recommend gray cast iron. Please see the 'Materials' section on p10 for more details.

Packing

Bollards are generally packed and shipped on a steel pallet or in a steel frame. This protects units against paint damage during transport, and allows for easy handling. The method is subject to change, particularly when required by the delivery route or destination.

Maintenance

Bollards are designed to cope with very large loads and extreme weather conditions. To maintain full working capacity and a long working life, they should be inspected periodically and given routine maintenance if required. Inspections should cover a range of factors that can cause wear and tear, including:

- Wear due to mooring ropes
- Loose or damaged fixings
- Unauthorized repairs and alterations
- Nearby works such as grinding or shotblasting
- Paint and solvent spills
- Bird guano

The inspection and maintenance regime should conform to all applicable laws and regulations for the region, especially with regard to safety and environmental protection. The facility's mooring and operational procedures should always include references to bollard safe working loads and other design limits.

Bollard inspections

Vessels, quay structures and equipment should never come into direct contact with bollards. Regular visual inspections should be carried out, and more detailed examination if bollards have been subjected to extreme loads or impact.

Important: if any cracks or holes are detected in a bollard it should be retired from use immediately, pending repair or replacement.

Check for visible damage or corrosion, damage to coatings, and missing, loose or bent bolts or nuts. All damage should be made good as soon as possible, to prevent safety issues and further problems with the bollard and the quay structure.

Please provide a full and detailed report of any damage as soon as possible to TekMarine, as failure to do so may affect warranties.

Coatings

A high-performance coating such as multi-layer C5M paint may last up to 15 years in normal use in a temperate climate, as long as paint damage is properly and routinely touched up. Hotter or corrosive environments may shorten this lifespan.

Most coatings can be made good on-site by properly qualified and equipped personnel. Please ask for advice from the paint manufacturer about any changes to their formulation, and about surface preparation before starting repairs. Health and safety regulations must always be followed, along with the paint manufacturer's quality control advice and health and safety datasheets such as MSDS or COSHH. The bollard should be removed to a suitable workshop for major paint repairs.

Anchors and fixings

Unless otherwise requested by the client, all TekMarine fixings are hot dip galvanized. Galvanized fixings rely on zinc deposits to protect against corrosion. These deposits typically last for about 5 years in the 'splash' zone of a temperate climate, and shorter periods in hotter or corrosive environments.

Inspections should look for depletion of the zinc layer or pitting to stainless steel. Non-destructive ultrasound testing may help to detect load damage to anchors below the quay surface. If in any doubt about anchor condition, please contact TekMarine for advice.

Spares

In the event of damage due to an incident, fixings can be relatively quick to order. Replacement bollards, however, have to be manufactured and transported to site. A small stock reserve will enable the facility to return to full operations much sooner.

Schedules

Part	Inspection schedule	Maintenance schedule		Refer to notes
		Interim	Full	
Steel/cast iron bollards	Yearly	As necessary	15–25 years	1, 2, 4, 5
Paint/coating system	Yearly	As necessary	10 years	1, 2, 4
Anchors and fastenings	Yearly	As necessary	15–25 years	1, 3, 4

Notes

- 1 As well as regular visual inspections, a closer visual inspection should follow any berthing incident, including exceptional impacts and extreme load conditions. A complete record should immediately be made of each event.
- 2 Interim maintenance should include repairs to paintwork damaged by mooring lines, bird guano and other factors, as well as repairing dents and similar damage due to overloads, accidents and extraordinary or unforeseen circumstances.
- 3 Interim maintenance should include the tightening of any loose fixings and the installation of preventative measures such as locking tabs to prevent reoccurrence, as well as the replacement of all missing or damaged fixings.
- 4 Full maintenance should follow a detailed inspection and the decision to replace, repair or refurbish any affected bollards, coatings and fixings. The decision-making process and repairs should be carried out in consultation with an engineer approved by TekMarine.
- 5 No allowance is made for corrosion of steel or cast iron unless specified in the designs.

In case of any doubt about inspection or maintenance please contact TekMarine.



Inspection form

Client	
Port	
Berth	
Date installed	
Date inspected	

Inspector	
Name	
Position	
Phone	
Email	

Bollard casting		
Wear	<input type="checkbox"/> Yes	<input type="checkbox"/> No
Bend	<input type="checkbox"/> Yes	<input type="checkbox"/> No
Crack or hole	<input type="checkbox"/> Yes	<input type="checkbox"/> No
Other damage	<input type="checkbox"/> Yes	<input type="checkbox"/> No

Further details

Coating system		
Wear or scrapes	<input type="checkbox"/> Yes	<input type="checkbox"/> No
Impact damage	<input type="checkbox"/> Yes	<input type="checkbox"/> No
Installation fault	<input type="checkbox"/> Yes	<input type="checkbox"/> No
Major corrosion or damage	<input type="checkbox"/> Yes	<input type="checkbox"/> No

Further details

Anchors and fixings		
Properly tightened	<input type="checkbox"/> Yes	<input type="checkbox"/> No
Damage to threads	<input type="checkbox"/> Yes	<input type="checkbox"/> No
Deformed or bent	<input type="checkbox"/> Yes	<input type="checkbox"/> No
Corrosion (galvanized)	<input type="checkbox"/> Yes	<input type="checkbox"/> No
Pitted (stainless steel)	<input type="checkbox"/> Yes	<input type="checkbox"/> No
Missing	<input type="checkbox"/> Yes	<input type="checkbox"/> No

Further details

Other information

Please return this form, fully completed, to info@tekmarine.com after every inspection.



Unit Conversions

Length

	m	ft	in
1 m =	1	3.281	39.37
1 ft =	0.3048	1	12
1 in =	0.0245	0.0833	1

Force

	kN	tonne-f	ton-f
1 kN =	1	0.102	0.225
1 tonne-f =	9.81	1	2.2046
1 ton-f =	4.45	0.454	1

Area

	m ²	ft ²	in ²
1 m² =	1	10.764	1550
1 ft² =	0.0929	1	144
1 in² =	645.2×10 ⁻⁶	6.944×10 ⁻³	1

Energy

	kNm	tf-m	ft.kip
1 kNm =	1	0.102	0.7376
1 tf-m =	9.81	1	7.233
1 ft.kip =	1.36	0.138	1

Volume

	m ³	ft ³	in ³
1 m³ =	1	35.315	61024
1 ft³ =	0.0283	1	1728
1 in³ =	16.387×10 ⁻⁶	578.7×10 ⁻⁶	1

Pressure

	kPa	t/m ²	kip/ft ²
1 kPa =	1	0.102	0.0209
1 t/m² =	9.81	1	0.205
1 kip/ft² =	47.9	4.88	1

Velocity

	m/s	ft/s	km/h	mph	knot
1 m/s =	1	3.2808	3.6	2.2369	1.9438
1 ft/s =	0.3048	1	1.0973	0.6818	0.5925
1 km/h =	0.2778	0.9113	1	0.6214	0.54
1 mph =	0.447	1.4667	1.6093	1	0.869
1 knot =	0.5144	1.6878	1.852	1.1508	1

Acceleration

	g	m/s ²	ft/s ²
1 g =	1	9.807	32.17
1 m/s² =	0.102	1	3.281
1 ft/s² =	0.031	0.3048	1

Important note

US customary units are listed for your convenience in this catalog, however figures in metric prevail throughout.

Useful software

At the time of publication, third-party unit conversion tools include:

Convert for Windows: <https://joshmadison.com/convert-for-windows/>

NumericalChameleon: <http://sourceforge.net/projects/numchameleon/>

TekMarine offers no warranty for nor makes any claims as to accuracy or fitness for purpose of these programs.



TEKMARINE



TEKMARINE SYSTEMS LLC
9595 Six Pines Drive, Suite 8210
The Woodlands
Houston, TX 77380, USA

phone +1 832 631-6104
email sales@tekmarine.com
web www.tekmarine.com

Presented by

Catalogue version 001b